



matteolighting.com  
info@matteolighting.com

Toll: 1 844 628 8368  
Tel: 604 560 5136

Canada: 100-1873 Forge Place Abbotsford, BC V2T 0L2  
USA: 6875 Speedway Blvd. Ste 106 Las Vegas, NV 89115

Project: \_\_\_\_\_

Company: \_\_\_\_\_

Location: \_\_\_\_\_ SPEC #: \_\_\_\_\_

Approved On: \_\_\_\_\_ Approved By: \_\_\_\_\_



VANITY

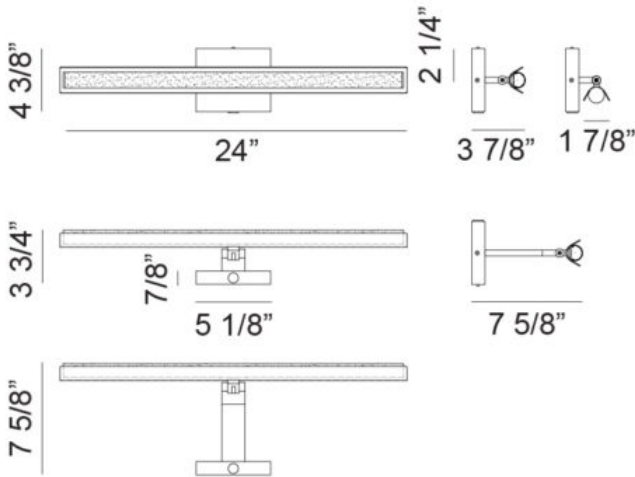

**Description**

**Harper**

Timeless elegance meets modern versatility. The Harper picture light features a streamlined silhouette that elevates artwork, mirrors, and architectural details. Its elongated, gently curved shade delivers even, ambient illumination, while the adjustable arm allows precise light placement. Designed for both style and performance, it provides a soft, inviting glow that enhances any space without overpowering it. Ideal for galleries, hallways, living rooms, or any setting that benefits from sophisticated accent lighting.

\*Features a 5CCT push-button to adjust the 5 selectable colour temperature

**S19324MB**

**Specifications**

FINISH .....	Matte Black
SHADE .....	Polycarbonate
DIMENSION .....	24"W x 4 3/8"H x 3 3/4"E or 7 5/8"E
H/CTR .....	2 1/4"
LAMPING .....	1 x 20W LED 120V
INITIAL LUMEN .....	2000
DELIVER LUMEN .....	1500
CRI(RA) .....	90
LED AVERAGE RATED LIFE .....	50,000 hours
COLOR TEMP .....	2700K, 3000K, 3500K, 4000K or 5000K
CANOPY COLOR .....	Matte Black
CANOPY SIZE .....	5 1/8"W x 4 3/8"H x 7/8"E
LOCATION .....	Damp
WARRANTY .....	5 years Warranty on LED Board

**Notes**

